

Ø315/Ø425 JESMIG AFLØBSRIST

Type 1 Grate

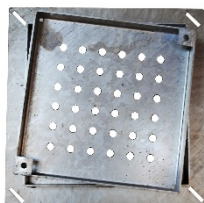

Tekniske data	T1-50G Rist	T1-70G Rist
Brøndstørrelse	Ø315 / Ø425 mm	Ø315 / Ø425 mm
Ydre karm mål Y	527 x 527 mm	527 x 527 mm
Ydre dæksel mål M	410 x 410 mm	410 x 410 mm
Lysåbning L	367 x 367 mm	367 x 367 mm
Belægnings højde F	50 mm	70-80 mm
Karm højde H	59 mm	79 mm
Vandgennemstrømning:	1,2 l/s	1,2 l/s
Max belastning	1,5 ton	1,5 ton
Brønddæksel vægt	14 kg	16 kg
Bestillingsnummer	227099130	227099133

Afløbsristen T1-50G typer fås med stenmix indstøbt i riste skålen. Stenmixen fås i 4 standart farver hvid, grå, sort og rødlig

Bestillingsnummeret med stenmix er 227099131 samt type farve

Varenr.	DB nr.	Beskrivelse	Materiale:	EN-klasse	Vægt i Kg:
227099130	1722474	Ø315/Ø425	Galvaniseret Smedejern	A 15	14
227099133	1832158	Ø315/Ø425	Galvaniseret Smedejern	A 15	16

Testet & Godkendt af Teknologisk institut iht. norm. DS/EN 124 rapportnummer: 560899-1
Prøvning af permeabiliteten med ilagt stenmix type NCC DrænAF – Rapport nr. 638662



Ø315/Ø425 JESMIG AFLØBSRIST

Type 1 Grate

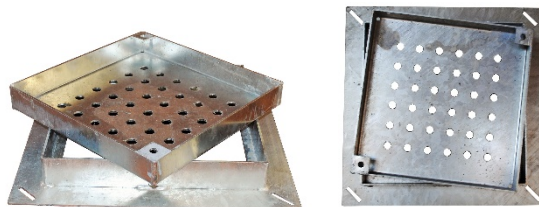

Type 1-50 Grate & 1-70 Grate

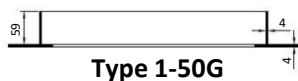

Type 1-50G

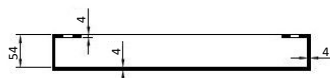

Type 1-50G

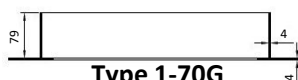

Type 1-70G



Type 1-70G

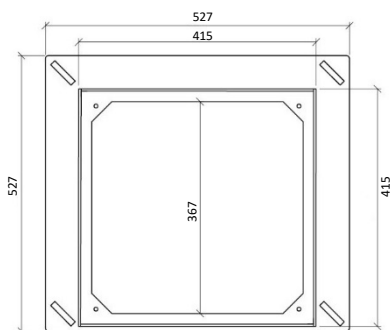

Type 1-50G & 1-70G

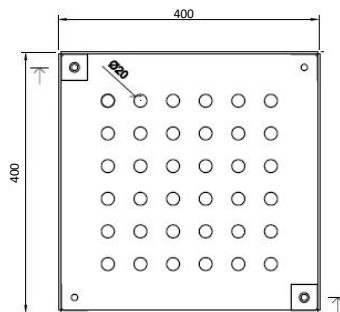

Type 1-50G & 1-70G

Varenr.	DB nr.	Beskrivelse	Materiale:	EN-klasse	Vægt i Kg:
227099130	1722474	Ø315/Ø425	Galvaniseret Smedejern	A 15	14
227099133	1832158	Ø315/Ø425	Galvaniseret Smedejern	A 15	16

Testet & Godkendt af Teknologisk institut iht. norm. DS/EN 124 rapportnummer: 560899-1
 Prøvning af permeabiliteten med ilagt stenmiks type NCC DrænAF – Rapport nr. 638662

