

Ø315/Ø425 JESMIG BRØNDDÆKSEL

T3



T3-50, T3-70 og T3-135-70

Tekniske data	T3-50	T3-70	T3-135-70
Brøndstørrelse	Ø315/Ø425 mm	Ø315/Ø425 mm	Ø315/Ø425 mm
Ydre karm mål Y	527 x 475 mm	527 x 475 mm	527 x 475 mm
Ydre dæksel mål M	400 x 400 mm	400 x 400 mm	400 x 400 mm
Lysåbning L	367 x 367 mm	367 x 367 mm	367 x 367 mm
Belægningshøjde	30-55 mm	60-75 mm	60-75 mm
Karmhøjde H	60 mm	83 mm	135 mm
Max belastning u/sten	B 125/ 12,5 ton	B 125/ 12,5 ton	B 125/ 12,5 ton
Brønddæksel vægt u/b	9 kg.	10 kg.	10 kg.

Varenr.	DB nr.	Beskrivelse	Materiale:	EN-klasse	Total Vægt i Kg:
227099300	1722167	Ø315/Ø425	Galvaniseret Smedejern	B125	16
227099320	1722168	Ø315/Ø425	Galvaniseret Smedejern	B125	18
2270 99327	1978787	Ø315/Ø425	Galvaniseret Smedejern	B125	20

Ved anvendelse af Jesmig tætningslister, kan der opnås en lugttæthed på 99 % gennem dækslet

Testet & Godkendt iht. norm. DS/EN 124

2020-01-01

Ø315/Ø425 JESMIG BRØNDDÆKSEL

T3



T3-50, T3-70 og T3-135-70

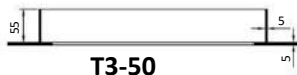

T3-50

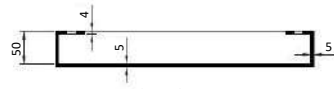

T3-50

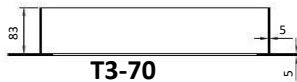

T3-70

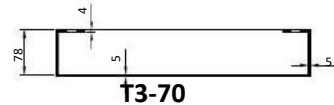

T3-70

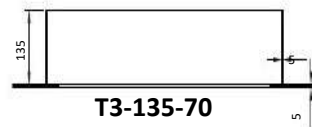

T3-135-70

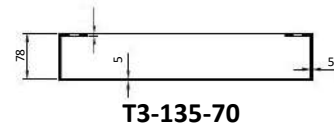

T3-135-70

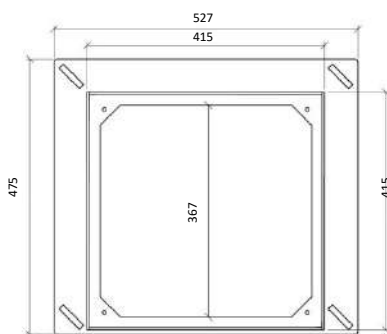

T3-50 , T3-70 og T3-135-70

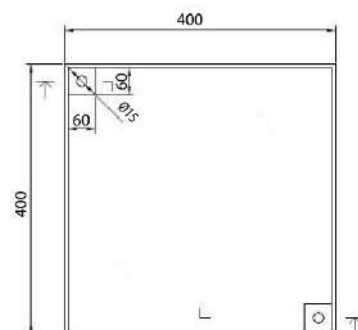

T3-50, T3-70 og T3-135-70

2020-01-01