

Ø315/Ø425 JESMIG BRØNDDÆKSEL

T1



T1-50, T1-70 og T1-135-105/70

Tekniske data	T1-50	T1-70	T1-135-70	T1-135-105
Brøndstørrelse	Ø315/Ø425 mm	Ø315/Ø425 mm	Ø315/Ø425 mm	Ø315/Ø425 mm
Ydre karm mål Y	527 x 475 mm	527 x 475 mm	527 x 475 mm	527 x 475 mm
Ydre dæksel mål M	400 x 400 mm	400 x 400 mm	400 x 400 mm	400 x 400 mm
Lysåbning L	367 x 367 mm	367 x 367 mm	367 x 367 mm	367 x 367 mm
Belægningshøjde	10-59 mm	60-79 mm	60-79 mm	60-105 mm
Karmhøjde H	59 mm	79 mm	135 mm	135 mm
Max belastning m/sten	A 50 / 5 ton	A 50 / 5 ton	A 50 / 5 ton	A 50 / 5 ton
Brønddæksel vægt u/b	7 kg.	8 kg.	8 kg.	10 kg.

Varenr.	DB nr.	Passer til brøndstørrelse	Materiale:	EN-klasse	Total Vægt i Kg:
2270 99100	1722126	Ø315/Ø425	Galvaniseret Smedejern	A 50	14
2270 99120	1722166	Ø315/Ø425	Galvaniseret Smedejern	A 50	16
2270 99127	1978786	Ø315/Ø425	Galvaniseret Smedejern	A 50	18
2270 99128		Ø315/Ø425	Galvaniseret Smedejern	A 50	20

Ved anvendelse af Jesmig tætningslister, kan der opnås en lugttæthed på 99 % gennem dækslet

Testet iht. norm. DS/EN 124-1, 3:2015 rapportnummer: 2021-0308

2023-31-01

Ø315/Ø425 JESMIG BRØNDDÆKSEL

T1



T1-50, T1-70 og T1-135-70

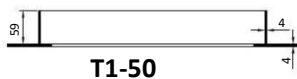

T1-50

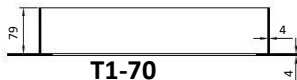

T1-70

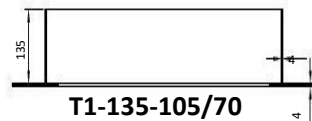

T1-135-105/70

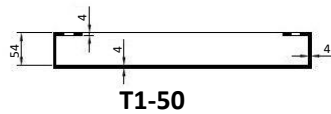

T1-50

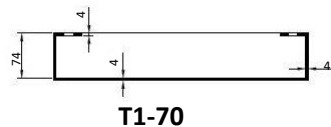

T1-70

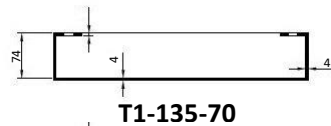

T1-135-70

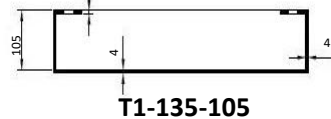

T1-135-105

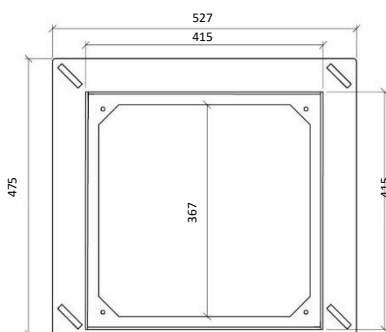

T1-50, T1-70 og T1-135-105/70

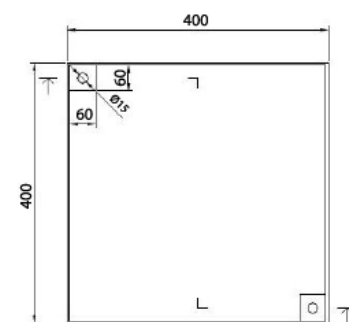

T1-50, T1-70 og T1-135-105/70