

## Ø315/Ø425 JESMIG BRØNDDÆKSEL

### T3 – B125

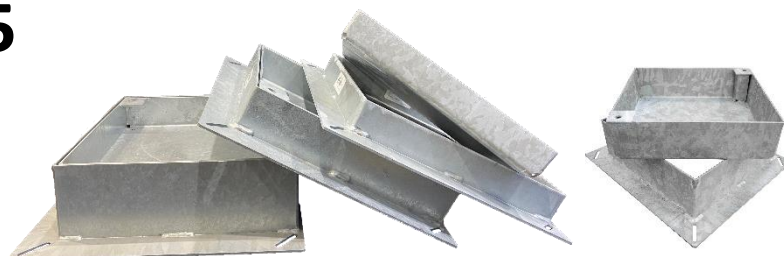

**T3-50, T3-70 og T3-135-105/70**

Tekniske data	T3-50	T3-70	T3-135-70	T3-135-105
Brøndstørrelse	Ø315/Ø425 mm	Ø315/Ø425 mm	Ø315/Ø425 mm	Ø315/Ø425 mm
Ydre karm mål Y	527 x 527 mm	527 x 527 mm	527 x 527 mm	527 x 527 mm
Ydre dæksel mål M	400 x 400 mm	400 x 400 mm	400 x 400 mm	400 x 400 mm
Lysåbning L	367 x 367 mm	367 x 367 mm	367 x 367 mm	367 x 367 mm
Belægningshøjde	10-59 mm	60-79 mm	60-79 mm	60-105 mm
Karmhøjde H	59 mm	79 mm	135 mm	135 mm
Max belastning m/sten	B 125 / 12,5 ton	B 125 / 12,5 ton	B 125 / 12,5 ton	B 125 / 12,5 ton
Brønddæksel vægt u/b	9 kg.	10 kg.	10 kg.	12 kg.

Varenr.	DB nr.	Passer til brøndstørrelse	Materiale:	EN-klasse	Total Vægt i Kg:
2270 99300	1722167	Ø315/Ø425	Galvaniseret Smedejern	B 125	16
2270 99220	1722168	Ø315/Ø425	Galvaniseret Smedejern	B 125	18
2270 99327	1978787	Ø315/Ø425	Galvaniseret Smedejern	B 125	20
2270 99328		Ø315/Ø425	Galvaniseret Smedejern	B 125	22

Ved anvendelse af Jesmig tætningslister, kan der opnås en lugttæthed på 99 % gennem dækslet

Testet iht. norm. DS/EN 124-1, 3:2015 rapportnummer: 2021-0308

2024-31-03

## Ø315/Ø425 JESMIG BRØNDDÆKSEL

### T3 – B125

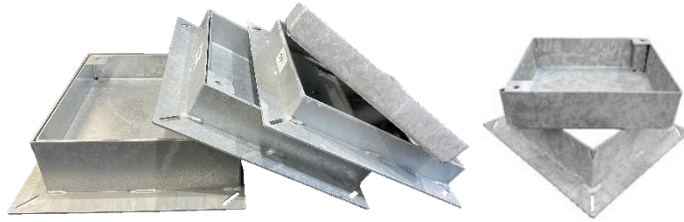

T3-50, T3-70 og T3-135-105/70



T3-50

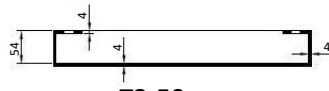

T3-50

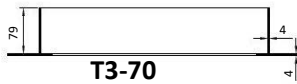

T3-70

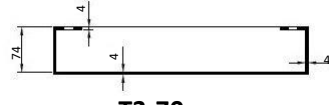

T3-70

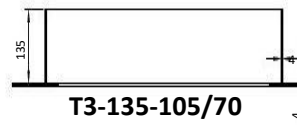

T3-135-105/70

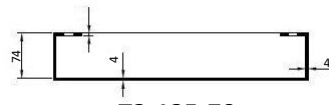

T3-135-70

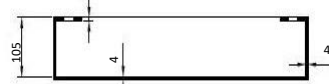

T3-135-105

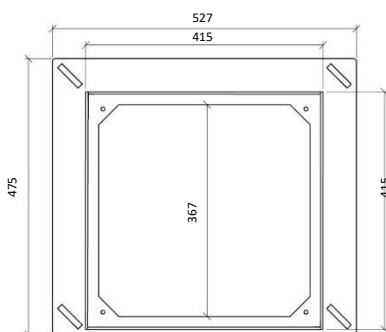

T3-50 , T3-70 og T3-135-105/70

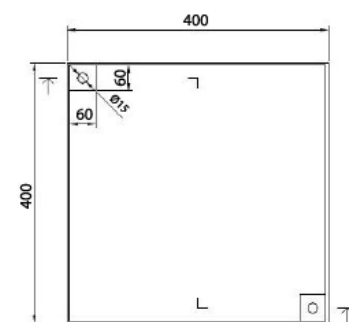

T3-50, T3-70 og T3-135-105/70