

Ø315/Ø425 JESMIG BRØNDDÆKSEL

T5

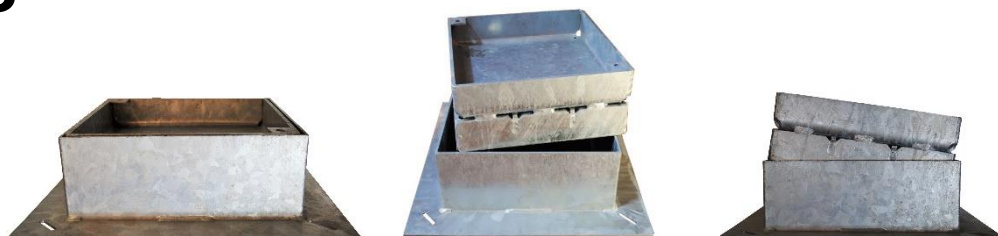

T5-80

Tekniske data	T5-80
Brøndstørrelse	Ø315/Ø425 mm
Ydre karm mål Y	567 x 567 mm
Ydre dæksel mål M	400 x 400 mm
Lysåbning L	367 x 367 mm
Belægnings højde F	50-79 mm
Karm højde H	149 mm
Max belastning	D 400 / 40 ton
Brønddæksel vægt	kg.

Varenr.	DB nr.	Beskrivelse	Materiale:	EN-klasse	Brutto Vægt Kg:
227099600	1816137	Ø315/Ø425	Galvaniseret Smedejern	D 400	45

Ved anvendelse af Jesmig tætningslister, kan der opnås en lugttæthed på 99 % gennem dækslet

Testet & Godkendt af Teknologisk institut iht. norm. DS/EN 124 rapportnummer: 638651



2018-05-17

Ø315/Ø425 JESMIG BRØNDDÆKSEL

T5

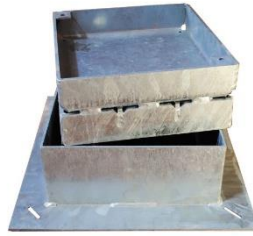

T5-80

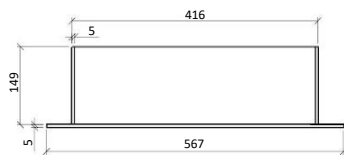

T5-80

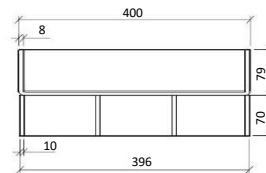

T5-80

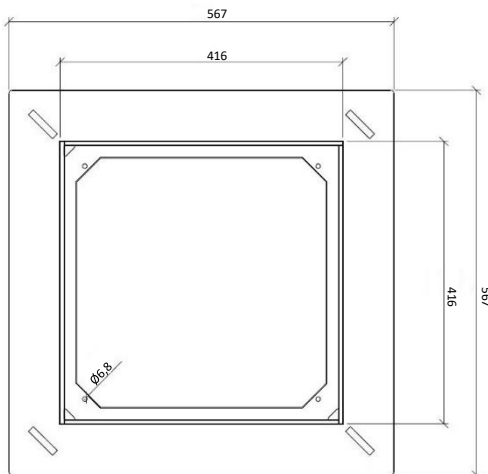

T5-80

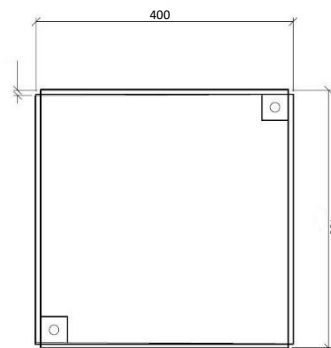

T5-80

Ved anvendelse af Jesmig tætningslister, kan der opnås en lugttæthed på 99 % gennem dækslet

Testet & Godkendt af Teknologisk institut iht. norm. DS/EN 124 rapportnummer: 638651



2018-05-17